

PCD-5R

AM/FM/MPX RADIO
WITH
FOLD-DOWN DETACHABLE FRONT PANEL,
5-DISC COMPACT DISC PLAYER
AND QUARTZ CLOCK



For Customer Service
Visit Our Website At
www.audiovox.com
Product Information, Photos,
FAQ's, Owner's Manuals

OWNER'S MANUAL

Released: 10-15-01

Revision A: 4-20-02 --- Added Remote Control description and incorporated other minor changes

INDEX

	Page
<i>Operating Instructions</i>	3 - 8
<i>Notes On Use of Front Panel</i>	8
<i>Setting the Clock</i>	9
<i>CD Player Error Codes</i>	9
<i>Specifications</i>	10
<i>Remote Control Unit</i>	10
<i>Care and Maintenance</i>	11
<i>Handling Compact Discs</i>	11
<i>CD-R Playback Capability</i>	11
<i>Warranty</i>	12

OPERATING INSTRUCTIONS

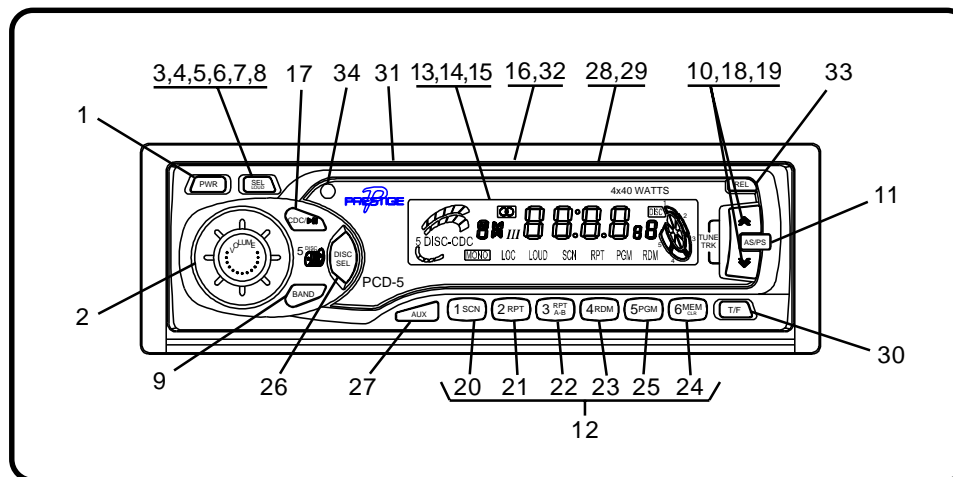

① POWER (PWR) BUTTON

Press this button to turn the unit on and off. When the ignition switch is on, the radio will turn on automatically when the CDC, BAND or AUX button is pressed.

② VOLUME CONTROL

To increase the volume level, rotate the VOLUME control in the clockwise direction. The volume will increase and the level will be shown on the display panel from a minimum of **V -0** to a maximum of **V -46**. To decrease the volume level, rotate the control in the counterclockwise direction. The display will automatically return to the normal indication 5 seconds after the last volume adjustment or when another function is activated. This control is also used in conjunction with the SEL/LOUD button to adjust the bass, treble, balance and fader levels as described in ④, ⑤, ⑥ and ⑦.

③ SELECT (SEL)/LOUD BUTTON

This button is used to select the audio function (volume, bass, treble, balance or fade) to be adjusted using the VOLUME control.

Pressing the Select button once will set the unit for volume adjustment (**VOL** will momentarily appear on the display panel, followed a few seconds later by **V --** and the setting number). Pressing the button additional times will select bass adjustment (**BAS** on display panel), treble adjustment (**TRE**), balance (**BAL**), fader (**FAD**), and volume (**VOL**) again. The display will return to the normal indication 5 seconds after the last adjustment or when another function is activated. Refer to paragraph ⑧ for the LOUD function of this button.

④ BASS CONTROL

To adjust the bass level, first select the Bass mode by pressing the SEL/LOUD button until the **BAS** indication appears on the display panel. Within 5 seconds of choosing the Bass mode, rotate the VOLUME Control to adjust the bass response as desired. The bass level will be shown on the display panel from a minimum of **B -6** to a maximum of **B +6** (**B 0** represents flat response). The display will automatically return to the normal indication 5 seconds after the last adjustment or when another function is activated.

⑤ TREBLE CONTROL

To adjust the treble level, first select the Treble mode by pressing the SEL/LOUD button until the **TRE** indication appears on the display panel. Within 5 seconds of choosing the Treble mode, rotate the VOLUME control to adjust the treble response as desired. The treble level will be shown on the display panel from a minimum of **T -6** to a maximum of **T +6** (**T 0** represents flat response). The display will automatically return to the normal indication 5 seconds after the last adjustment or when another function is activated.

⑥ LEFT/RIGHT BALANCE CONTROL

To adjust the left-right speaker balance, first select the Balance mode by pressing the SEL/LOUD button until the **BAL** indication appears on the display panel. Within 5 seconds of choosing the Balance mode, rotate the VOLUME control clockwise to adjust it to the right channel speakers, or counterclockwise to adjust it to the left channel speakers. The balance position will be shown on the display panel from **L 12** (full left) to **R 12** (full right). When the volume level between the left and right speakers is equal, **C 00** will be shown on the display panel. The display will automatically return to the normal indication 5 seconds after the last adjustment or when another function is activated.

⑦ FRONT/REAR FADER CONTROL

To adjust the front-rear speaker balance, first select the Fader mode by pressing the SEL/LOUD button until the **FAD** indication appears on the display panel. Within 5 seconds of choosing the Fader mode, rotate the VOLUME control clockwise or counterclockwise to adjust the front-rear speaker levels as desired. The fader position will be shown on the display panel from **F 12** (full front) to **R 12** (full rear). When the volume level between the front and rear speakers is equal, **C 00** will appear on the display panel. The display will automatically return to the normal indication 5 seconds after the last adjustment or when another function is activated.

⑧ LOUDNESS CONTOUR (LOUD)

When listening to music at low volume levels, this feature will boost the bass and treble ranges to compensate for the characteristics of human hearing. Press and hold the SEL/LOUD button for at least 2 seconds to activate this feature as indicated by **LOUD** on the display

panel. Pressing the button again for 2 seconds will de-activate the function and **LOUD** will disappear from the display.

⑨ AM/FM BAND SELECTOR

During radio play, each time the button is pressed, the radio band changes. The indications **AM**_I, **AM**_{II}, **FM**_I, **FM**_{II}, or **FM**_{III} will appear on the display panel according to your selection.

During CD play, pressing this button will change to radio operation without ejecting the disc.

⑩ UP/DOWN TUNING (▲ / ▼)/CD TRACK (TRK) SELECTION

During radio operation, each time the Up TUNE button (▲) is pressed, the radio will tune two frequency steps higher. Similarly, each press of the Down TUNE button (▼) will tune two frequency steps lower. Pressing either button for longer than 1 second and then releasing will activate the automatic seek tuning function, whereby the radio will seek the next station in the selected direction and stop and remain at that frequency.

Pressing and holding either button for longer than 1 second will cause the radio to continue tuning rapidly in the selected direction until the next available station and momentarily stop there. Tuning will continue unless the button is released at the desired station.

During CD player operation, these buttons are used to select a desired track on the disc. (Refer to **Track Select**.)

⑪ AUTO-STORE TUNING (AS) PRE-SET SCAN TUNING (PS)

Press this button momentarily to scan the 6 stations in the pre-set memories of the band in use. The unit will stop at each pre-set station for 10 seconds before continuing to the next pre-set station (the frequency on the display panel will flash during Pre-Set Scan operation). Press the button again momentarily to stop Pre-Set Scan operation and remain on the selected frequency.

Pressing the button for longer than 2 seconds will activate the Auto-Store Tuning feature. The radio will automatically scan the band in use and enter strong local stations into the pre-set memory positions for that band.



LOC will appear on the display as tuning occurs. If you have already set the pre-set memories of that band to your favorite stations, activating the Auto-Store Tuning feature will erase those stations and enter the new stronger stations. This feature is most useful when traveling in a new area where you are not familiar with the local stations.

⑫ STATION PRE-SET MEMORIES

To manually set any of the 6 pre-set memory buttons, use the following procedure:

1. Turn the unit on and select the desired band.
2. Select the first station to be pre-set using the TUNE/TRK buttons.
3. Press and hold the pre-set button to be set for approximately 2 seconds. The pre-set number **CH 1-6** will appear on the display, indicating the station is now set into the memory position of that pre-set button and can be recalled at any time by momentarily pressing that button.
4. Repeat the above procedure for the remaining 5 pre-sets on the band in use and for the other 4 bands of the unit.

⑬ FM STEREO/MONO/LOCAL (LOC) INDICATIONS

The unit receives both stereo and monaural signals. During FM radio operation, the unit is usually receiving a stereo signal as indicated by the stereo icon () on the display. If a stereo signal is too weak for comfortable listening, the stereo indication will appear intermittently or not at all; if an AM or monaural signal is received, the  icon will disappear from the display panel.

⑭ LIQUID CRYSTAL DISPLAY PANEL

The Liquid Crystal Display (LCD) panel displays the frequency, time, and activated functions.

NOTE: It is a characteristic of LCD panels that, if subjected to cold temperatures for an extended period of time, they may take longer to illuminate than under normal conditions. In addition, the visibility of the numbers on the LCD may slightly decrease. The LCD readout will return to normal when the temperature increases to a normal range.

⑮ FUNCTION DISPLAY

The Function Display consists of a single bar graph which displays a bar graph which provides a visual representation of the audio signal power level. As the volume is increased, the number of illuminated segments will increase.

⑯ DISC SLOT

With the label surface facing up, gently insert each disc into the slot until the soft-loading mechanism engages and draws the disc into the player. The number of discs loaded will appear both on the front panel display disc icon (flashing white segment) and on the **DISC INF** display on the rear of the front panel. The discs will be loaded in order beginning with the number (1-5) currently displayed. Disc play will begin when the CDC button is pressed; and play will start with track 1 on the last disc loaded, unless another disc is selected using the DISC SEL button on the front side of the panel.

NOTE: This unit is designed for play of standard 5" (12cm) Compact Discs **ONLY**. Do not attempt to use 3" (8cm) CD-Singles in this unit, either with or without an adapter, as damage to the player and/or disc can occur. Such damage will not be covered by the Warranty on this product.

⑰ CD PLAY/PAUSE SELECTOR (CDC/▶II)

When listening to radio with a disc loaded in the unit ( on the display panel), press this button to return to disc play mode from the beginning of the last track in play.

During disc play, press this button to temporarily stop play of the disc (**PAUS** will appear on the display panel). Press the button again to resume play from the point at which it was stopped. Pause mode will also be canceled by activating any other disc function.

⑱ TRACK (TRK) SELECT (⏮ ⏭)

The Track Select functions are used to quickly access the beginning of a particular track. Each time the Forward Track Select (⏮) button is pressed, the next higher track number will be selected as shown on the display panel. Similarly, each time the Backward Track Select (⏭) button is pressed, the next lower track number will be selected as shown on the display panel.

⑲ CUE/REVIEW FUNCTIONS (⏮ ⏭)

High-speed audible search to any section of the disc can be made by the Cue and Review functions. Press and hold the Cue button (⏮) to advance rapidly in the forward direction or the Review button (⏭) to advance rapidly in the backward direction. During either function, the elapsed time within each track will automatically be shown on the display panel.

⑳ TRACK SCAN SELECTOR (SCN)

During disc play, press this button to play the first 10 seconds of each track on the disc (**SCN** will appear on the display panel and the track number will flash). When a desired track is reached, press the Track Scan button again to cancel the function and play of the selected track will continue. Track Scan mode will also be canceled by activating the Repeat Play or Random Play functions.

㉑ TRACK REPEAT PLAY SELECTOR (RPT)

During disc play, press this button to repeat the play of the selected track (**RPT** will appear on the display panel). Play of the track will continue to repeat until the button is pressed again and the **RPT** indication disappears from the display panel. Repeat Play mode will also be canceled by activating the Track Scan or Random Play functions.

㉒ REPEAT A - B SELECTOR (RPT A-B)

The Repeat A - B function is used to select a section of the disc other than a complete track to be repeated. Press the button at the beginning of the section that you wish to have repeated (**RPT** and **A** will appear on the display panel). Allow the disc to play to the end of the section that you wish to have repeated and then press the button again (the **A** on the display panel will change to a **b**). The selected section will be played repeatedly until the function is canceled by pressing the RPT A-B button again or activating any other disc function.

㉓ RANDOM PLAY SELECTOR (RDM)

During disc play, press this button to play the tracks on the disc in a random shuffled order (**RDM** will appear on the display panel). In Random Play mode, the Forward Track Select (⏮) will also select tracks in the random order instead of the normal progression. Backward Track Select (⏭) will go back to the beginning of the track in play if it has played longer than 5 seconds or to a random track if it has played less than 5 seconds. The Random Play mode can be canceled by pressing the button again (**RDM** indication will disappear from the display panel).

㉔ MEMORY/CLEAR SELECTOR (MEM/CLR)

Up to 18 tracks can be programmed for play in any order you select. The following procedure is used to program the order of track play:

1. Select a disc into the unit to begin disc play.
2. Select the first track to be programmed using the Track Select buttons (TUNE/TRK) and press the **MEM** Selector button. The indication **M - 01** will momentarily appear on the display panel, indicating that the selected track has been entered as the first one to be played in Programmed Play mode.
3. Select the second track to be programmed (this could be on another disc) using the Track Select button and then press the Memory Selector button. **M - 02** will appear on the display The selected track has been entered as the second one to be played in Programmed Play mode.

4. In similar manner, continue selecting other tracks (up to a maximum of 18) to be played in programmed order. The indication **FULL** will appear on the display panel if attempting to program more than 18 selections.

⑳ PROGRAMMED PLAY SELECTOR (PGM)

To play the tracks in the selected order after programming is completed, press the Programmed Play button so that the **PGM** indication appears on the display panel. Play will begin on the first track selected in the programmed order. During Programmed Play mode, the Track Select functions will operate in the programmed order instead of the normal progression. Track Scan and Track Repeat can be selected during Programmed Play and will operate on the programmed tracks.

To de-activate Programmed Play and return to play of all tracks on the disc in normal order, press the Programmed Play button again so that the **PGM** disappears from the display panel. Activating the Cue/Review functions or the Random Play mode will also cancel Programmed Play mode.

Clearing Programmed Play Memory: To clear the Programmed Play memory, press the Memory Clear button at any time during Programmed Play mode (**PGM** on display panel). **PGM** will disappear from the display panel, **M --- CL** will appear momentarily, and the program will be erased. The Programmed Play memory will also be cleared automatically when the disc(s) is ejected.

NOTE: Program Play memory will be maintained if the disc is left in the player when the unit is shut off.

㉑ DISC SELECT (DISC SEL) BUTTON

When this button is pressed during disc play, the next CD in order is selected for play. The selected **DISC** segment number (1-5) is highlighted on the front panel disc icon () and flashes while play is active. Otherwise, the segment number lights steadily during radio operation if the disc(s) is still installed.

㉒ AUXILIARY (AUX) BUTTON

If a portable audio device, is connected to the Left and Right auxiliary input jacks, this source can be selected for play through the radio by pressing the AUX button. When the button is pressed, **A --in** appears on the display panel. When the auxiliary input is being used, no other audio input sources (radio or CD) are operational.

㉓ PANEL DISC SELECT (DISC SEL) BUTTON

The back of the front panel contains a DISC SEL button which is used in conjunction with the disc number LCD and Disc Eject () button to select a particular CD you wish to remove and/or replace. When the DISC SEL button is pressed, the disc number display to the left sequences through discs **1-5**; stop at the number disc you wish to eject and press the eject button. The selected disc will be ejected.

㉔ DISC EJECT ()

Disc play is stopped; the disc currently selected for play is ejected and the unit will change to radio operation by pressing this button (**EJT** will briefly appear on the display panel). When the disc is ejected, **no cd** appears on the display; press **BAND** to return to radio operation. The disc must be removed from the unit or be reloaded. Pressing the Disc Eject button for at least 2 seconds will eject all discs from the unit in sequence, beginning with the disc currently in play.

㉕ TIME/FREQUENCY DISPLAY SELECTOR (T/F)

Press this button to call the time display on the incorporated quartz clock. Press the button again to return to radio frequency or disc display, or it will return automatically after 5 seconds.

㉖ THEFT-DETERRENT LED

A light-emitting diode (LED) with lens is mounted on the front of the chassis behind the panel mounting plate; the LED will flash at 1-second intervals when the panel folds down, and will flash at 2-second intervals when the panel is removed from the radio. The flashing light serves as both a visual reminder that the panel has been released, or as a warning to a would-be thief that the unit has been disabled by removal of the front panel.

③② RESET BUTTON

A RESET button is accessible on the rear of the front panel when it is in the fold-down position. The reset circuitry is provided to protect the microprocessor circuitry and should only be activated under the following circumstances.

1. Upon initial installation after all wiring is completed.
2. If there is a malfunction of any of the switches on the unit or of the CD player, pressing the RESET button may clear the system and return the unit to normal operation.

CAUTION: Pressing the RESET button will cause all discs to be ejected. When the RESET button is pressed be certain that the front panel is in the down position.

③③ FRONT PANEL RELEASE (REL) BUTTON

This button is used to release the mechanism that holds the front panel to the chassis. To detach the front panel, press the button; the panel will fold down to the horizontal position. At the center of the panel, press the release clip to disengage the panel from the mounting plate, and pull the panel straight out until it clears the mounting plate guides. To re-attach the panel, position the panel so both sides engage the mounting plate guides; then slide the panel home until the mechanism locks it into place in the mounting plate.

③④ INFRARED SIGNAL SENSOR



This sensor detects the signal transmitted by the PCD-5 Remote Control unit. Make sure the Remote Control is pointed directly at this sensor window area on the front panel when accessing radio and CD functions.

NOTES ON USE OF FRONT PANEL

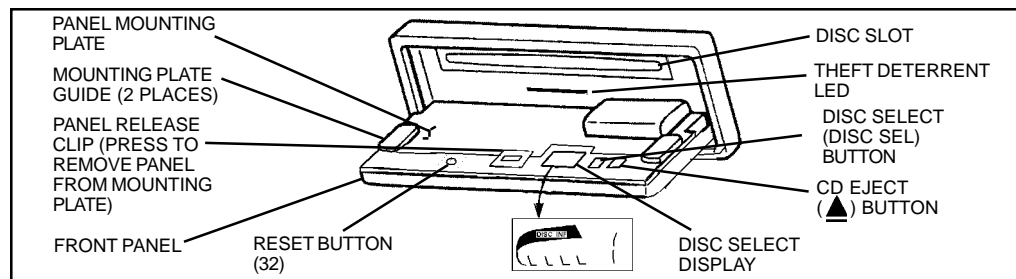
1. Make sure the front panel is right-side up when attaching it to the chassis as it cannot be attached when up-side down.
2. Do not press very hard on the front panel when attaching it to the chassis. No more than light to moderate pressure should be needed.
3. When attaching the front panel, make sure the right side is correctly engaged before pressing the left side to lock it into position.
4. When taking the front panel with you, please use the supplied carrying case to protect the panel from dirt and damage.









SETTING THE CLOCK

1. Switch the vehicle ignition on and the radio on (radio frequency or disc track number will be shown on the display panel).
2. Press and hold the Time/Frequency (T/F) button approximately 2 seconds until the time display appears with **AM** or **PM** and the colon (:) flashing. Release the T/F button.
3. Press the Down Tuning button () to adjust the hours and the AM/PM indication, and the Up Tuning button () to adjust the minutes to the correct time.
4. When the correct time is shown on the display panel, wait 5 seconds for the display to return to the normal indication.

CD PLAYER ERROR CODES

If a problem should develop while operating the CD player, the following error codes may be displayed on the display panel:

- INF-1:** Indicates mechanical malfunction. Press the Reset button .
- INF-2:** Indicates mechanical malfunction. Press the Reset button .
- INF-3:** Indicates mechanical malfunction. Press the Reset button .
- INF-4:** Indicates disc focus error. Press the Reset button .
- INF-5:** Indicates disc focus error. Press the Reset button .
- INF-6:** Indicates mechanical malfunction. Press the Reset button .
- INF-7:** Indicates data error. Press the Reset button .
- INF-8:** Indicates disc reading error. Eject the disc, make sure it is clean, undamaged, and loaded correctly (label side up). Re-load the disc and check for proper operation or try another disc.
- INF-9:** Indicates disc lever error. Press eject button.

If the suggested measures do not solve the problem, contact an approved warranty station near you for further assistance.

SPECIFICATIONS

Size:	7" W x 2" H x 6-1/4" D 178 mm x 50 mm x 160 mm
Operating Voltage:	12 volts DC, negative ground
Output Power:	160 watts maximum (40 watts x 4 channels)
Output Wiring:	Floating-ground type designed for 4 speaker use. Front and rear channels CANNOT be combined (bridged) for use with 2 speakers. RCA low-level outputs (rear channels).
Output Impedance:	Compatible with 4-8 ohm speakers.
Low-Level Output:	2.0 Volts (2000 mv)
Tuning Range:	AM: 530-1,720 kHz. (10 kHz step) FM: 87.5-107.9 MHz. (200 kHz step)
Sensitivity:	AM: 20 uV. FM: 3.0 uV.
FM Stereo Separation:	30 dB
CD Frequency Response:	20-20,000 Hz. ±1 dB
CD Signal/Noise Ratio:	70 dB
CD Channel Separation:	60 dB
CD Distortion:	0.10%

*Specifications are subject to change without notice.

REMOTE CONTROL UNIT

- BAND** Button: Same function as radio BAND selector ⑨.
- POWER** Button: Same function as radio PWR ①.
- VOL** \wedge / \vee Buttons: Same function as radio VOLUME +/- ②.
- IR Transmitter**: Emits IR function signal to radio sensor ④.
- SEL/LOUD** Button: Same function as radio SEL/LOUD ③.
- PLAY/PAUSE** (\blacktriangleright ||) Button: Same function as radio CDC/ \blacktriangleright || ⑰.
- TUNE/TRK** (\ll / \gg) Buttons: Same function as radio ⑩.
- AUX** Button: Same function as radio ⑳.
- RPT A-B** Button: Same function as radio ㉒.
- PGM** Button: Same function as radio ㉕.
- MEM CLR** Button: Same function as radio ㉘.
- MUTE** Button: When this button is pressed during radio or CD operation, **MUTE** appears on the display, audio is muted, and all other radio or CD play functions, except for the audio level display, disappear. When pressed again, **MUTE** disappears from the display and normal radio or CD audio is restored.
- CLK** Button: Same function as radio Time/Frequency button ㉚.
- AS/PS ELPS** Button: Same function as radio AS/PS button ①.
- RDM** Button: Same function as radio ㉛.
- Station Presets 1-6**: Same function as radio ⑫.
- SCN** Button: Same function as radio ㉜.
- RPT** Button: Same function as radio ㉝.
- DISC SEL** Button: Same function as radio ㉞.

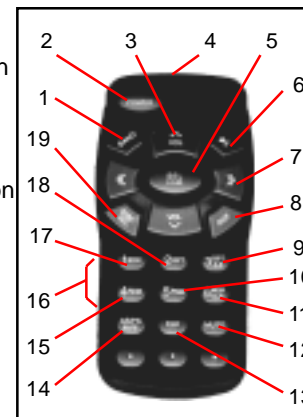

CARE AND MAINTENANCE

The radio section of your new sound system does not require any maintenance. We recommend you keep this manual for reference on the many features found in this unit as well as how to set the clock.

The compact disc player section also requires no routine maintenance, but proper understanding of its use and handling will help you obtain maximum enjoyment of its capabilities. The following points should be observed:

- When cleaning the interior of the vehicle, do not get water or cleaning fluids on the unit.
- The CD player is a precision instrument and will not operate properly in extreme hot or cold. In case of such conditions, wait until the interior temperature of the vehicle reaches a normal temperature before using the player.
- If the temperature inside the player gets too hot, a protective circuit will automatically stop play of the disc. In this case, allow the unit to cool off before operating the player again.
- Never insert anything other than a 5" (12 cm) compact disc into the player as the mechanism can be damaged by foreign objects.
- Do not attempt to use 3" (8 cm) CD-Single discs in this unit, either with or without an adaptor, as damage to the player and/or disc may occur. Such damage will not be covered by the Warranty on this product.
- When not using the disc player, always remove the compact disc.
- When the vehicle warms up during cold weather or under damp conditions, moisture may condense on the lens of the disc player. Should this occur, the player will not operate properly until the moisture has evaporated.
- The unit is designed with a vibration dampening CD mechanism to minimize interruption of disc play due to normal vibration in a moving vehicle. When driving on very rough roads, however, occasional sound skips may occur. This will not scratch or damage the disc and normal play will resume when the rough conditions cease.

HANDLING COMPACT DISCS

Dirt, dust, scratches, and warpage can cause skips in the playback and deterioration of sound quality. Please follow these guidelines to take care of your compact discs:

- Use only compact discs with the mark: The logo consists of the word "COMPACT" in a small font above the word "disc" in a large, stylized font, with "DIGITAL AUDIO" in a small font below it.
- Fingerprints, dust, and dirt should be carefully wiped off the disc's playing surface (shiny side) with a soft cloth. Wipe in a straight motion from the inside to the outside of the disc.
- Never use chemicals such as record sprays, household cleaners or thinner to clean compact discs. Such chemicals can irreparably damage the disc's surface.
- Discs should be kept in their storage cases when not in use.
- Do not expose discs to direct sunlight, high temperatures or high humidity for extended periods.
- Do not stick paper, tape, or labels on the disc surfaces nor write on them with any type of marker.

CD-R PLAYBACK CAPABILITY

This model can play most CD-R media that contains audio programs.

Playback of CD-R depends on the conditions of the recording equipment and the CD-R disc quality. In some cases, a CD-R disc cannot be played on this unit.



12 / 24 MONTH LIMITED WARRANTY

Applies to automotive radios, radio/tape players, radio/CD players, CD changers, power amplifiers, equalizers and accessories.

AUDIOVOX CORPORATION (the Company) warrants to the original retail purchaser of this product that should this product or any part thereof, under normal use and conditions, be proven defective in material or workmanship within 12 months from the date of original purchase, such defect(s) will be repaired or replaced with new or reconditioned product (at the Company's option) without charge for parts and repair labor. To obtain repair or replacement within the terms of this Warranty, the product is to be delivered with proof of warranty coverage (e.g. dated bill of sale), specification of defect(s), transportation prepaid, to an approved warranty station or the Company at the address shown below. The warranty period will be extended to 24 months from the date of original purchase if the product is installed by an authorized Prestige Audio dealer. To claim warranty service during this extended period, the bill of sale must specify that the product was installed by an authorized Prestige Audio dealer.

This Warranty does not extend to the elimination of externally generated static or noise, to correction of antenna problems, to costs incurred for installation, removal or reinstallation of the product, or to damage to tapes, compact discs, speakers, accessories, or vehicle electrical systems.

This Warranty does not apply to any product or part thereof which, in the opinion of the Company, has suffered or been damaged through alteration, improper installation, mishandling, misuse, neglect, accident, or by removal or defacement of the factory serial number/bar code label(s). THE EXTENT OF THE COMPANY'S LIABILITY UNDER THIS WARRANTY IS LIMITED TO THE REPAIR OR REPLACEMENT PROVIDED ABOVE AND, IN NO EVENT, SHALL THE COMPANY'S LIABILITY EXCEED THE PURCHASE PRICE PAID BY PURCHASER FOR THE PRODUCT.

This Warranty is in lieu of all other express warranties or liabilities. ANY IMPLIED WARRANTIES, INCLUDING ANY IMPLIED WARRANTY OF MERCHANTABILITY, SHALL BE LIMITED TO THE DURATION OF THIS WRITTEN WARRANTY. ANY ACTION FOR BREACH OF ANY WARRANTY HEREUNDER INCLUDING ANY IMPLIED WARRANTY OF MERCHANTABILITY MUST BE BROUGHT WITHIN A PERIOD OF 30 MONTHS FROM DATE OF ORIGINAL PURCHASE. IN NO CASE SHALL THE COMPANY BE LIABLE FOR ANY CONSEQUENTIAL OR INCIDENTAL DAMAGES FOR BREACH OF THIS OR ANY OTHER WARRANTY, EXPRESS OR IMPLIED, WHATSOEVER. No person or representative is authorized to assume for the Company any liability other than expressed herein in connection with the sale of this product.

Some states do not allow limitations on how long an implied warranty lasts or the exclusion or limitation of incidental or consequential damage so the above limitations or exclusions may not apply to you. This Warranty gives you specific legal rights and you may also have other rights which vary from state to state.

U.S.A. : AUDIOVOX CORPORATION, 150 MARCUS BLVD., HAUPPAUGE, NEW YORK 11788 • 1-800-645-4994

CANADA : CALL 1-800-645-4994 FOR LOCATION OF WARRANTY STATION SERVING YOUR AREA

128-5543